



***BK7000***

***High Definition Videoscope***

***Operating Manual***

# General Safety Information



Read and understand all instructions. Failure to follow all instructions listed below may result in electric shock, fire and/or serious personal injury.

## Work Area Safety

- Keep your work area clean and well lit. Cluttered benches and dark areas may cause accidents.
- Do not operate electrical devices or video scope tool in explosive atmospheres, such as in the presence of flammable liquids, gases, or heavy dust. Electrical devices or visual inspection tools create sparks which may ignite the dust or fumes.
- Do not use the video scope around corrosive chemicals.
- Keep bystanders, children, and visitors away while operating visual inspection tool. Do not let visitors contact the unit.

## Personal Safety

- Stay alert, watch what you are doing and use common sense. Do not use video scope while tired or under the influence of drugs, alcohol, or medications. A moment of inattention while operating tools may result in serious personal injury.
- Do not overreach. Keep proper footing and balance at all times. Proper footing and balance enables better control of the tool in unexpected situations.
- Use safety equipment. Always wear eye protection (users and bystanders). Dust mask, non-skid safety shoes, hard hat, or hearing protection must be used for appropriate conditions.
- Use proper accessories. Do not place this product on any unstable cart or surface.
- The product may fall causing serious injury to a person or serious damage to the product. Prevent object and liquid entry. Never spill liquid of any kind on the video display unit. Liquid increases the risk of electrical shock and damage to the product.
- Do not use this device for personal or medical use/inspection in any way.
- The unit is not shock-resistant. Do not use it as a hammer or drop it.



To reduce the risk of serious injury, read these precautions carefully before using the battery charger or battery.



### **A/C Power Supply**

- Do not probe A/C power supply with conductive objects. Shorting of battery terminals may cause sparking, burning or electrical shock.
- Do not use A/C power supply if damaged. A damaged A/C power supply increases the risk of electrical shock.
- Use an appropriate power source. Do not attempt to use a step-up transformer or an engine generator. Doing so may cause damage to the A/C power supply of the BK7000 resulting in electrical shock, fire or burns.
- Do not allow anything to cover the A/C power supply while in use. Proper ventilation is required for correct operation of the A/C power supply. Allow a minimum of 4" (10 cm) of clearance around the charger for proper ventilation.
- Unplug the A/C power supply when not in use. Reduces the risk of injury to children and untrained persons.

- . Unplug the A/C power supply from outlet before attempting any maintenance or cleaning. Reduces the risk of electrical shock.
- . Do not use A/C power supply in a damp, wet or explosive environment. Do not expose to rain, snow or dirt. Contaminants and moisture increase the risk of electrical shock.
- . Do not open the A/C power supply or BK7000 housings. Have repairs performed only at authorized locations. (See Snap-on Service Center).
- . Do not carry the A/C power supply by power cord. Reduces the risk of electrical shock.

## Battery Safety

- The batteries in the BK7000 are NOT user replaceable. Call your Service Center if you believe the BK7000 battery is in need of service.
- Properly dispose of the BK7000. Exposure to high temperatures can cause the battery to explode, so do not dispose of in a fire. Some countries have regulations concerning battery disposal. Please follow all applicable regulations.
- Charge battery in temperatures above 32 degrees F (0 degrees C) and below 113 degrees F (45 degrees C). Store BK7000 in temperatures above -4°F (-20°C) and below 140°F (60°C). Storage for a long time at temperatures above 95°F (35°C) will reduce the capacity of the BK7000. It is recommended to store the BK7000 at 77°F (25°C) to maximize battery life. Proper care will prevent serious damage to the battery. Improper care of the battery may result battery leakage, electrical shock and burns.

## **Battery Safety continued**

- If the BK7000 is damaged, do not plug the A/C power supply into it. Do not attempt to charge.
- Never disassemble the BK7000 unit. There are no user-serviceable parts inside.
- Disassembling the BK7000 may cause electrical shock or personal injury.

Avoid contact with fluids leaking from the BK7000 unit. Fluids may cause burns or skin irritation. Thoroughly rinse with water in case of accidental contact with fluid. Consult doctor if fluid comes into contact with eyes.

## Video Scope Use and Care

- Use video scope only as directed. Do not operate the inspection unit unless the owner's manual has been read and proper training has been completed.
- Do not immerse the handheld display unit in water. Store in a dry place. Such measures reduce the risk of electric shock and damage. The imager head and the cable are water resistant when the unit is fully assembled, but the video display unit/handle is not.
- Do not use the camera if condensation forms inside the lens. Let the water evaporate before using again.
- Do not use tool if ON/OFF switch is not properly working. Any tool that cannot be controlled with the switch is dangerous and must be repaired.
- Store idle equipment out of the reach of children and other untrained persons. Equipment is dangerous in the hands of untrained users.
- Maintain the video scope with care. Properly maintained tools are less likely to cause injury.
- If unit is dropped, check for breakage of parts, and any other conditions that may affect the tool's operation. If



damaged, have the tool serviced before using. Many accidents are caused by poorly maintained tools.

- . Use only accessories that are recommended by the manufacturer for your tool. Accessories that may be suitable for one tool may become hazardous when used on another tool.
- . Dry your hands before turning the unit ON or OFF.
- . Protect against excessive heat. The product should be situated away from heat sources such as radiators, heat registers, stoves or other products (including amplifiers) that produce heat. Do not use the unit near moving machinery or areas where the temperature will exceed 140°F (60°C).

## Service

- Do not attempt to take any pieces of this unit apart unless directed to by this manual.
- Follow instructions for changing accessories. Accidents are caused by poorly maintained equipment.
- Provide proper cleaning. Do not use acetone to clean the unit. Instead, use isopropanol.
- Gently clean the LCD with a dry cloth.
- Stop using the unit if it starts smoking or emitting noxious fumes.
- Refer video scope to qualified service personnel if any of the following conditions are met:
  - If liquid has been spilled or objects have fallen into product;
  - If product does not operate normally by following the operating instructions;
  - If the product has been dropped or damaged in any way
  - When the product exhibits a noticeable change in performance.

If you have any questions regarding the service or repair of this machine, call or write to the appropriate repair center location (see "Snap-on Service Center Locations").

Technical questions can be directed to our toll free number at (877) 762-7664 Monday through Friday 6:30 am to 5:00 pm Central Time (U.S. customers only).

## Specific Safety Information

Read this operator's manual carefully before using. Failure to understand and follow the contents of this manual may result in electrical shock, fire and/or severe personal injury.

## FCC Statement

This device complies with Part 15 of the FCC Rules. Operation is subject to the following two conditions:

1. This device may not cause harmful interference.
2. This device must accept any interference received, including interference that may cause undesired operation. NOTE!

This equipment has been tested and found to comply with the limits for Class A digital devices, pursuant to Part 15 of the FCC rules. These limits are designed to provide reasonable protection against harmful interference in a residential installation. This equipment generates uses and can radiate radio frequency energy and, if not installed and used in accordance with the instructions, may cause harmful interference to radio communications. However, there is no guarantee that interference will not occur in a particular installation. If this equipment does cause harmful

interference to radio or television reception, which can be determined by turning the equipment off and on, the user is encouraged to try to correct the interference by one or more of the following measures:

- Reorient or relocate the receiving antenna.
- Increase the separation between the equipment and receiver.
- Consult the dealer for help.

Use of shielded cable is required to comply with Class A limits in Subpart B of Part 15 of the FCC rules.

Do not make any changes or modifications to the equipment.

This device complies with Part 15 of the FCC Rules and with Industry Canada license-exempt RSS standard(s).

Operation is subject to the following two conditions: (1) This device may not cause harmful interference, and (2) This device must accept any interference received, including reference that may cause undesired operation. Note: Changes or modification not expressly approved by the party responsible for compliance could void the user's authority to operate the equipment.

This Class A digital device complies with Canadian ICES-003.

## Video Scope Safety

- . Do not place tool into anything or anywhere that may contain a live electrical charge.
- . FOR WALLS: For inspecting inside walls, be sure to shut off the circuit breaker to the whole house before using the tool behind any of the walls
- . FOR PIPES: If you suspect a metal pipe could contain an electrical charge, have a qualified electrician check the pipe before using the tool. Ground circuits, in some cases, can be returned to cast iron pipes and cause them to be charged.
- . FOR AUTOMOBILES/HEAVY EQUIPMENT/ MOTORSPORTS: Be sure the automobile, heavy equipment or motorsport equipment is not running during inspection. Metal and liquid under the hood may be hot. Do not get oil or gas on the imager head. Exposure to petroleum-based substances will eventually degrade the imager head covering.

GENERAL USE: Do not use anywhere the unit may come into exposure with hazardous chemicals, electrical charges or moving parts. Such situations may result in serious injury or death.

## Product Description

The BK7000 digital high definition videoscope provides true HD video thanks to its high resolution imager paired with the high resolution LCD screen. The 5" screen makes any under the hood job easy to see... The BK7000 features a capacitive touch screen display and dual view picture in picture imager...

## Included with the BK7000:

1. BK7000 handheld unit
2. 5.5mm Dual view HD PiP imager (attached to unit)
3. Quick start guide
4. Power supply with 4 interchangeable power source adapters
5. USB-C to USB-A power cord
6. BK7000 travel case

# Specifications

## Getting Started

### Description

The BK7000 video scope displays live color video from an imaging sensor and lighting source connected to a flexible dual view imager cable. The unit is capable of capturing still images and full-motion video, along with audio. It can be used to look into tight spots and beam back real-time video to a true high definition color LCD.



## Specifications

Total Weight..... 1 lb. (800g)

### DISPLAY UNIT:

Power Supply..... Internal Li-Ion Battery, 3.7V, 3000 mAh, 9.6 watt-hours

Charge time..... 1.25 hours

Charger Input..... 5V DC, 1. Amp

Length..... 1.28" (32.5mm)

Width..... 6.75" (171.4mm)

Height.....3.77" (100mm)

Built-in Camera..... 1280 x 720 HD Fixed focus

Screen Resolution..... 1280 x 720 with LED backlight

5.0" (12.7 cm) Capacitive Color Touchscreen LCD

Audio Input.....Built-in Microphone

Audio Output.....Built-in Speaker

## DISPLAY UNIT Specifications:

Run-time on battery..... 2 hours (approximately)

Wireless interface..... 2.4 – 5GHz Wi-Fi - 802.11n

Wireless range..... 50 ft. (10m)

Operating Temperature..... 32°F to 140°F (0°C to 60°C)

(Batteries will not charge above 113°F (45°C))

Storage Temperature..... -4°F to 140°F (-20°C to 60° C )

77°F (25°C) is ideal for maximum battery life.

Relative Humidity.....5% to 90% non-condensing

## IMAGER:

Length..... 36 in (0.91m)

Forward Camera/Side Camera

Field of View..... approximately 62° diagonal

Optimal Focal Range..... 0.5" to 12" (12cm to 30.5cm)

Resolution..... 1280 x 720

Operating Temperature..... 32°F to 140°F (0°C to 60°C)

Storage Temperature..... -4°F to 140°F (-20°C to 60°C)

Relative Humidity..... 5% to 90% non-condensing

## A/C Power Supply:

Input Voltage.....100-240VAC, 50-60Hz 0.6Amp  
Maximum inrush current ..... 30A @ 115VAC, 60A @ 230VAC  
Output voltage ..... 5V DC 2.6Amp Max  
No Load Standby power ..... <0.3W  
Operating Temperature..... 32°F to 104°F (0°C to 40°C)  
Storage Temperature..... 14°F to 167°F (-10°C to 75°C)  
Relative Humidity..... 20% to 80% non-condensing

**NOTE! The charger and internal batteries are not compatible with any other Snap-on Li-Ion Batteries and chargers.**

## Available Accessories

BK7000-38FV - 3.8mm diameter, 36 inch forward view imager

BK7000-38SV - 3.8mm diameter, 36 inch side view imager

The 3.8mm diameter imagers are specifically designed to be able to pass through the glow plug port in a diesel engine. The side view will provide a high definition image of the cylinder walls and image of the valve profile. The forward facing imager will provide a clear image of the piston face and combustion cup.

# Feature Outlines

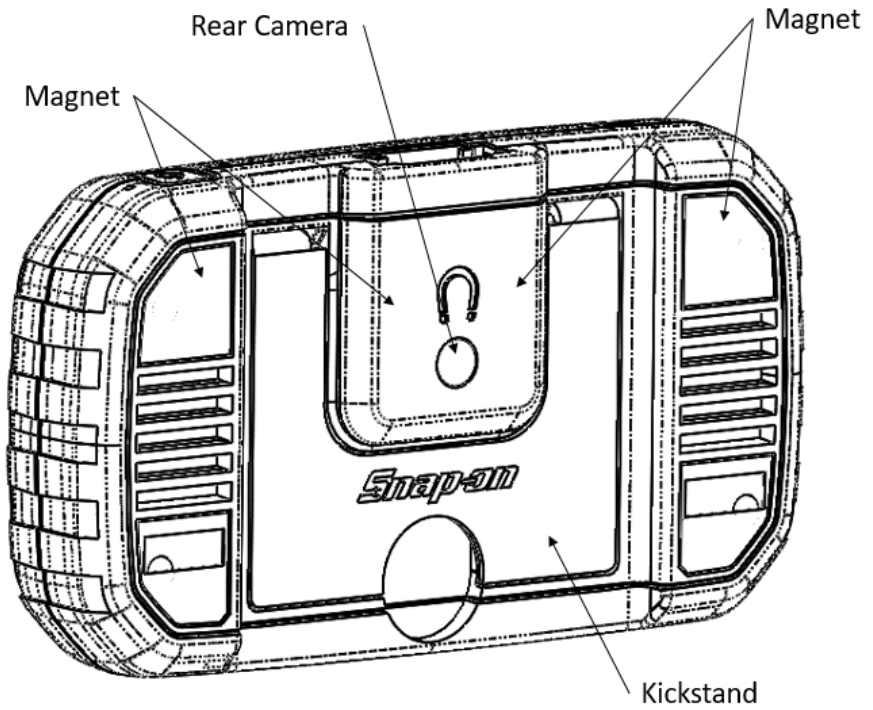
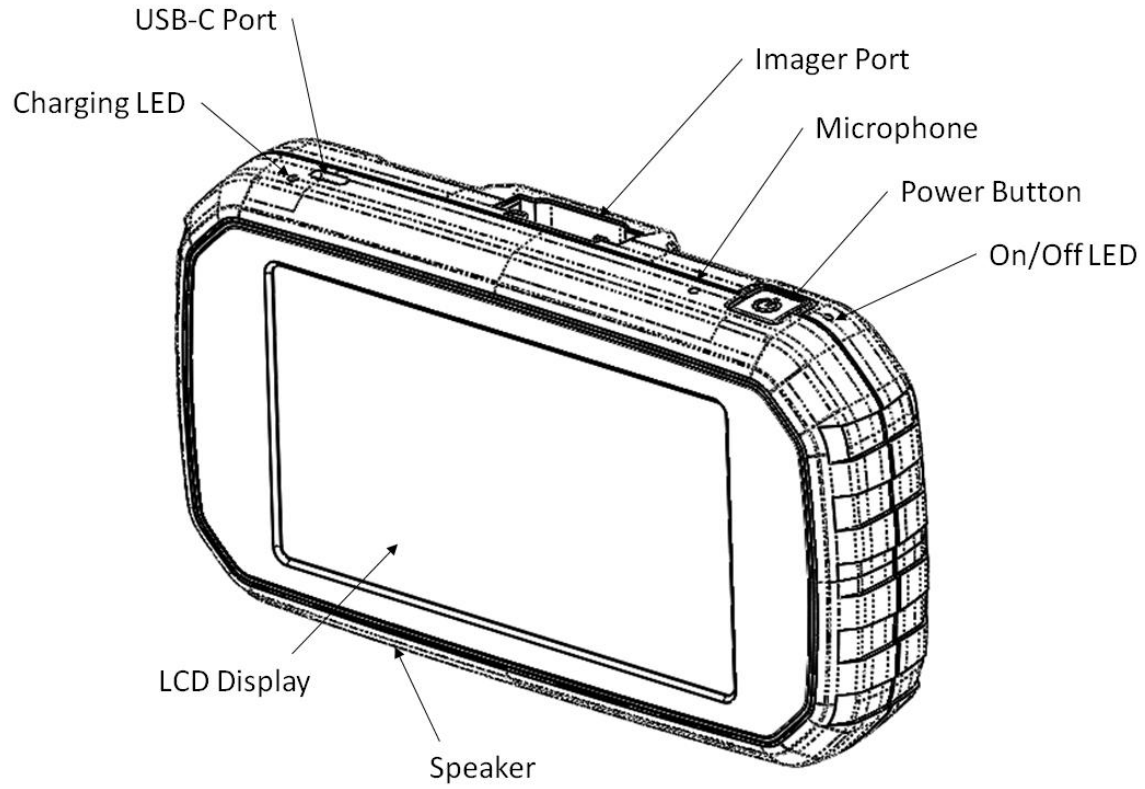

## Introduction



Do not operate the video scope in explosive atmospheres, such as in the presence of flammable liquids, gases, or combustible dust. This unit may create sparks which could ignite fumes or dust. No responsibility will be taken by Snap-on for any resulting damage to the unit or to the operator if it is used with corrosive, explosive, or otherwise dangerous gas and dust mixtures.



When using the video scope at the inspection site, make certain that you and the work area is safe for the unit to be used. This is not classified as flameproof or intrinsically safe; therefore, it must not be used where explosion hazard may exist. For complete details on product and operator safety, review the General Safety Information section.



# Setup

## Battery Requirements/Warnings



Daily, before use, inspect the BK7000 and A/C Power Supply and correct any problems. Set up charger according to these procedures to reduce the risk of injury from electrical shock, fire, and other causes and prevent tool and system damage.

Before using the BK7000 for the first time, allow it charge for at least 1.5 hours to ensure that the batteries are fully charged.

## Assembling the Charger

The charger is supplied with a selection of power outlet adaptors for use in multiple countries. Before first use, select the appropriate adaptor for your country and attach it by aligning the male notches on the back of the adapter with the female notches on the power block then twist clockwise, the adapter will click and lock into place. To switch adapter, push and hold down on the locking tap, located on the power block, and twist counterclockwise to release/open, see Figure 2.

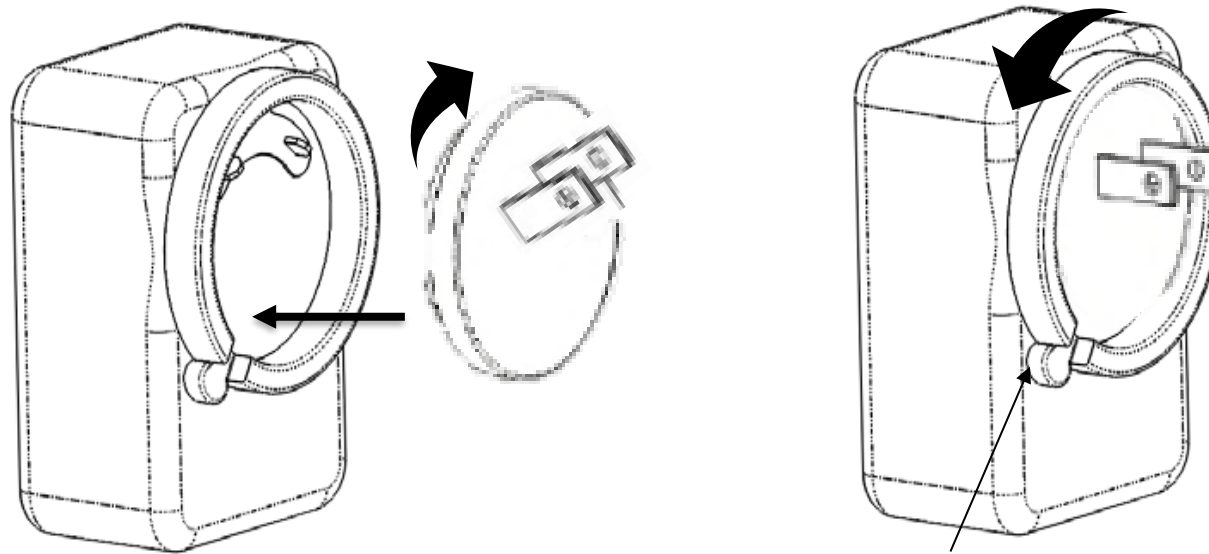
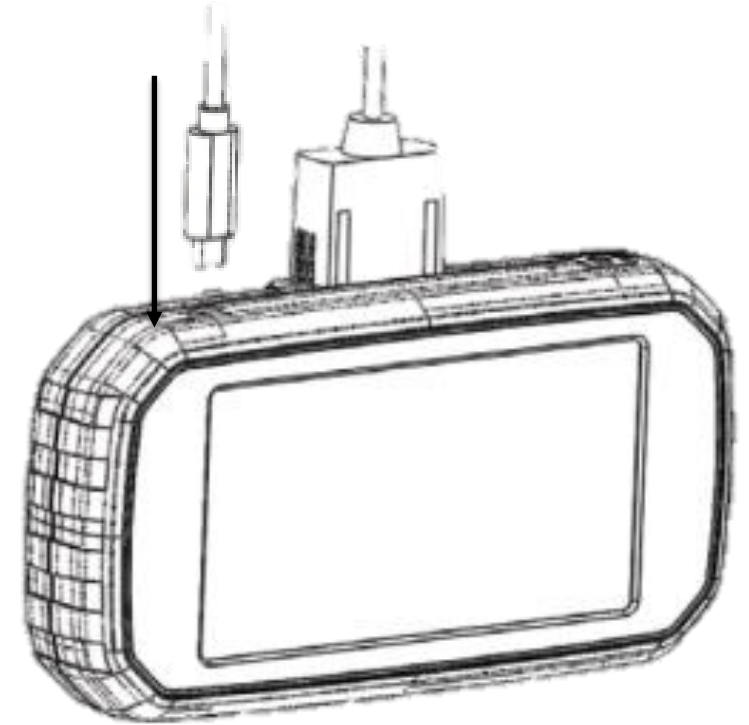

**Figure 2: Assemble/Disassemble Charger**

Lock

## Charging the Unit

With dry hands, insert the USB-C end of the power cord into the charging port as shown in Figure 3 and insert the USB-A end into the power block. Ensure that the correct adapter is fitted into the power block and insert the charger into a suitable power outlet to charge unit. When charging is complete remove USB-C



**Figure 3: Charging the Unit**

**NOTICE**

The BK7000 will only charge the batteries if the temperature is between 0°C and 45°C (32°F and 113°F). Outside of this temperature range the BK7000 may continue to operate but the batteries will not charge, and the Charge Status LED will be off. When the battery is fully charged, status LED will be illuminated solid green. There is no risk of overcharging the battery. When the battery has been fully charged, the charger automatically switches to retention charging.

**CAUTION**

Be sure to inspect the power cord and power block for any damages. If there are any broken or worn parts, exposed wires or any damage of this nature, do not use until parts are replaced. Be sure to keep the unit clean; free of oils, grease and dirt, as described in the Maintenance section. This will prevent the unit from slipping out of your hands and will allow proper unit ventilation.

# Charging Status

Charge Status	LED Status	Battery Status
Not Charging	LED is OFF	No power to battery
Charging	Green (blinking)	Battery is low
Fully Charged	Green (solid)	Battery is fully charged

## Disconnecting and Connecting Imagers

To switch imagers, first, turn the unit off. Then pinch and hold the sides of the connector and pull imager out of the unit. To connect an imager, align the male notches on the imager connector with the female notches on the unit and insert, see Figure 4.

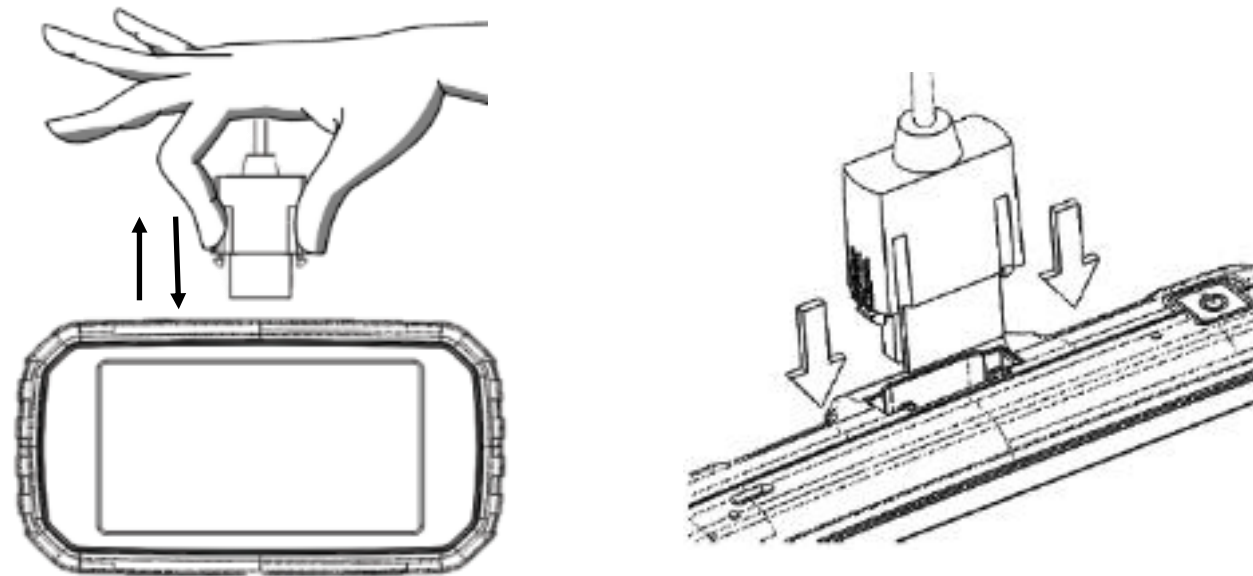

**Figure 4: Disconnect/Connect Imager**

## **Powering the Unit**

No assembly process is required. The unit can be powered on by pressing and holding the power button for 2 seconds. The unit will power on and the indicator light will illuminate.

To turn the unit off, press and hold the power button for 2 seconds and the unit will power off.



## Operation

The BK7000 requires an initial registry setup when powered on for the first time. Once the unit is registered, it will be ready use.

Power on the unit. Once the splash screen disappears, the language selection page will appear. Scroll through the languages and select one by clicking on the language bar. The blue arrow on the language bars indicates “next page”, see Figure 5.

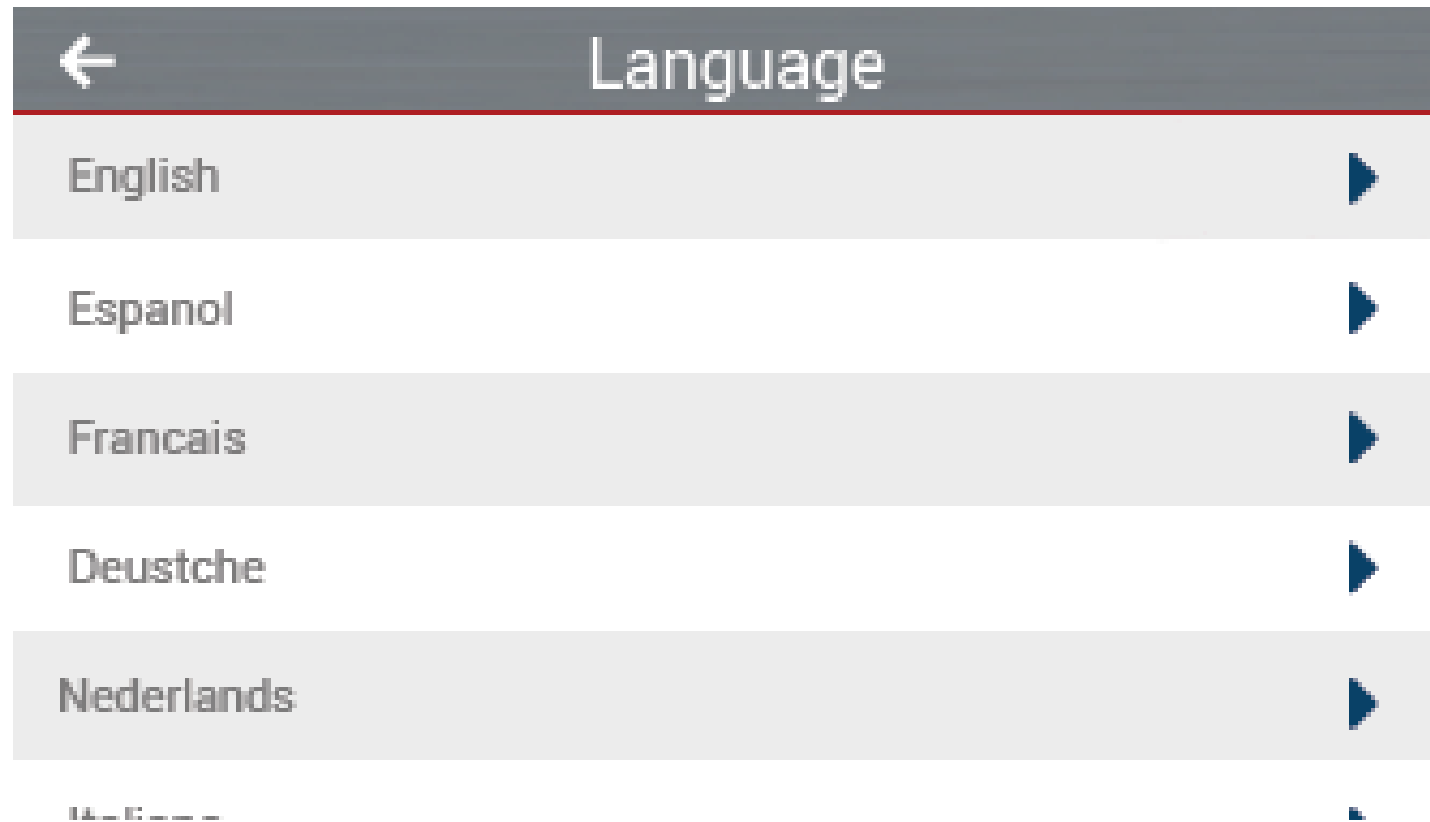

**Figure 5: Language Selection**

## Set Date/Time

After the language has been set, the next page will prompt you to select the time zone.

The time zone can be set to your choice or skipped and set later, see Figure 6. **Important:**

Setting the time zone allows for a time and date stamp on important documents and submissions.



# Date Time

--/--/----  
--:--



Date & Time can ONLY be set with timezone selection and Wifi setup

**Figure 6: Time Zone**



## Time Zone

LINT: Line Islands Time



TOT: Tonga Time



CHAST: Chatham Island Standard Time



ANAT: Anadyr Time



SBT: Solomon Islands Time



LINT: Line Islands Time





# Wifi Networks

INSPECTRON



INSPECTRONGUEST



MV500-V520M1100412



CBCI-EF0A



ROCAMminiHD:B9:62



ROCAMminiHD:B9:62



WiFi can be set by selecting an available network and entering a password. The WiFi setup can be skipped and set later, see Figure 7

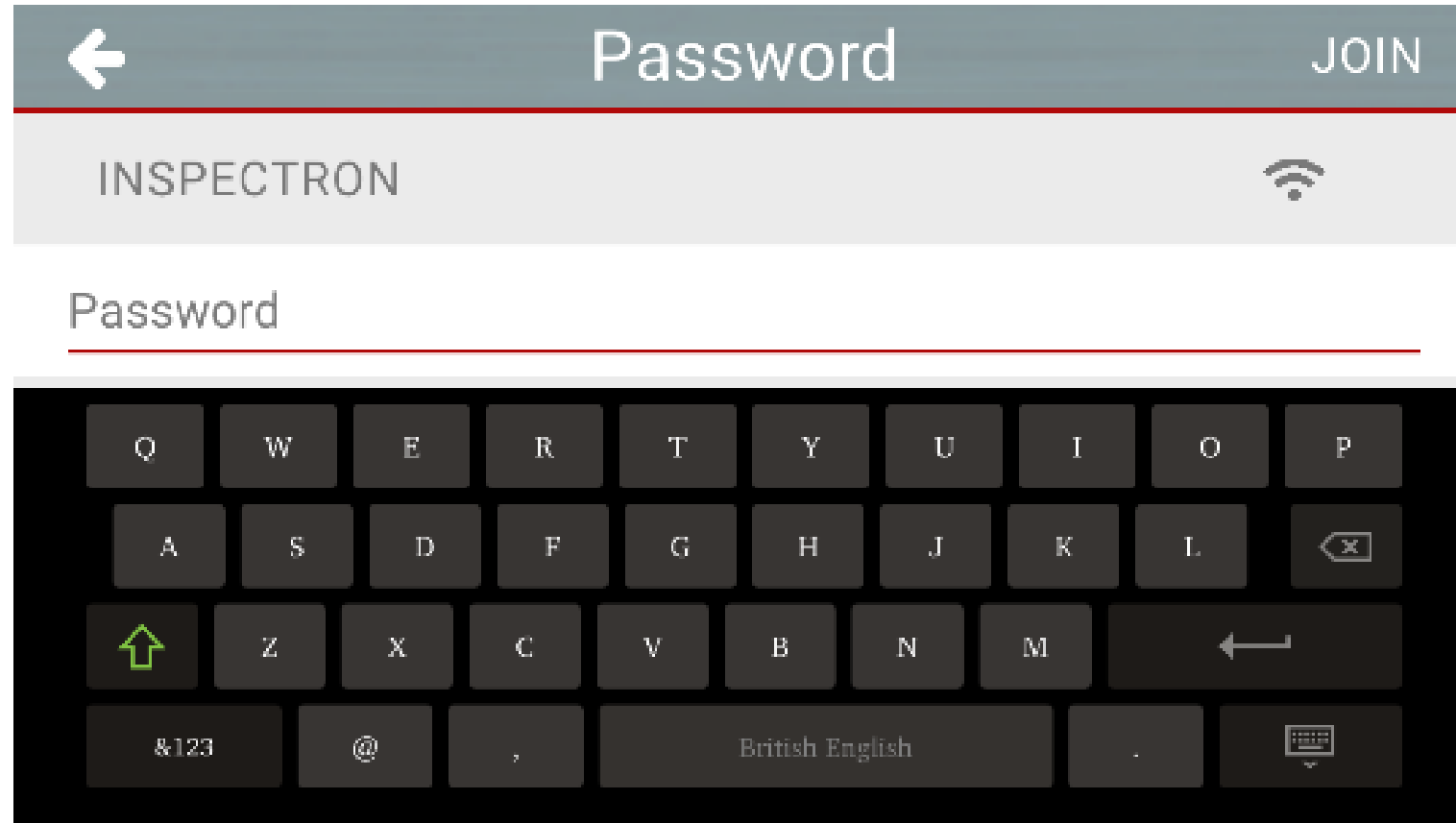

**Figure 7: WiFi Setup**

Once the password is entered, click on “JOIN” in the upper right corner.

**Important:** The time zone will only accurately impact the displayed time on the unit if the unit has an internet connection.

## Register Device

On the next page enter in your name, phone number, and email address. Then, tap the “REGISTER” button in the top right corner.



# Using the BK7000 Home screen button functionalities

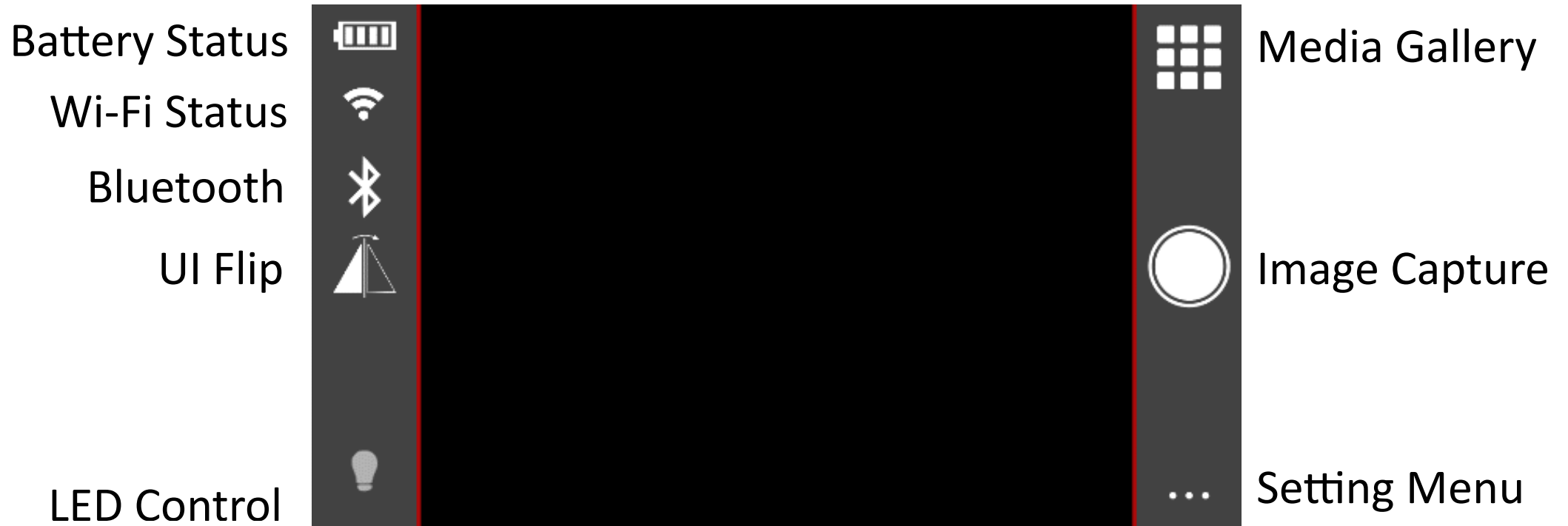

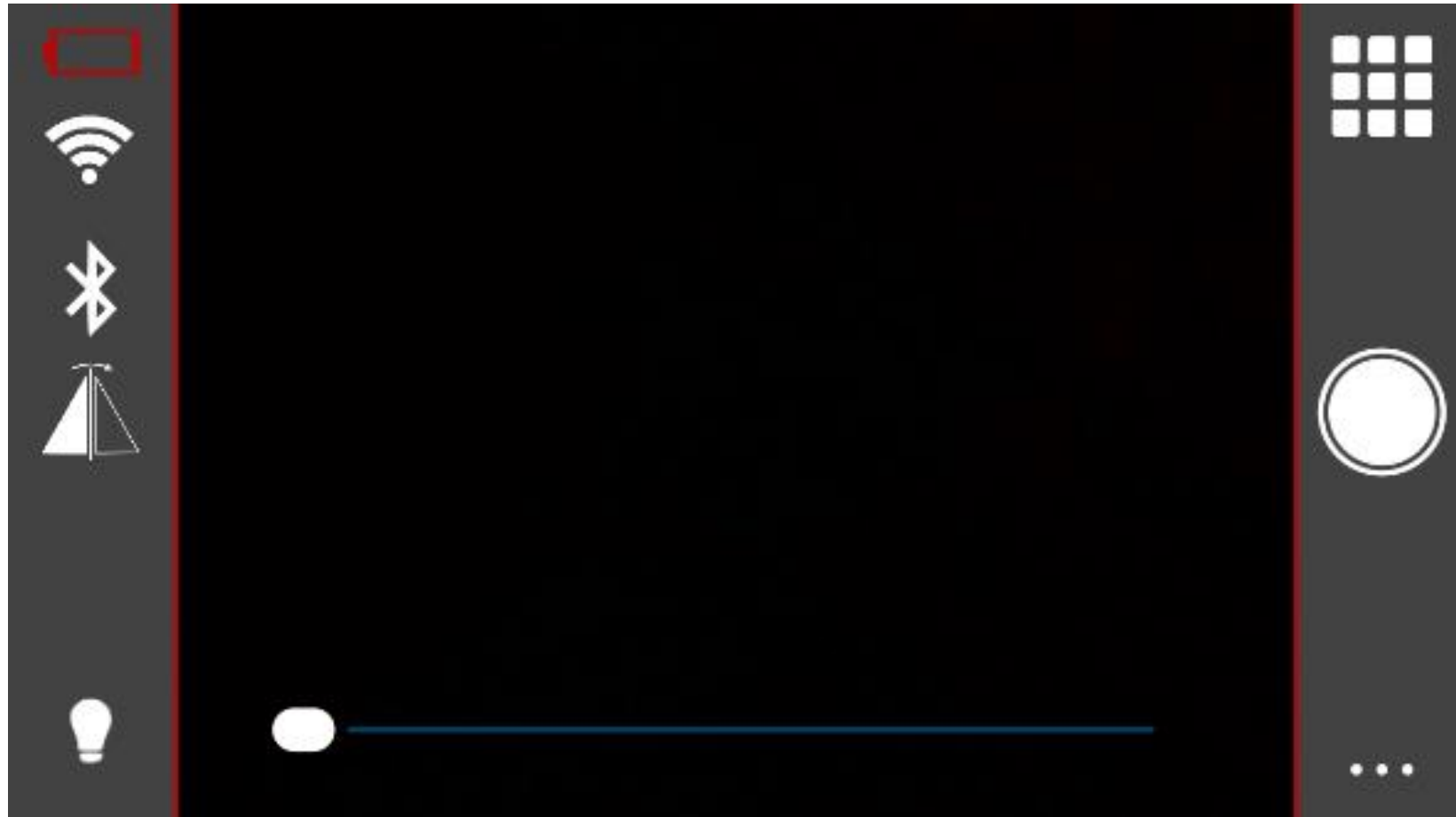

## LED control



Touch the light bulb icon to make the LED Slide appear

Battery icon on screen shows the status of the battery life

Battery Icon	Icon Color/Pattern	Battery Life Status
	White (solid)	Fully charged battery
	Red (blinking)	< 25% battery life remaining

## **Taking a picture**

Once satisfied with what is displayed on the screen, click on the shutter button. The screen will flash black, indicating that the picture was successfully taken. To view the screen in full display before taking the picture, tap the screen once; to redisplay screen icons, tap the screen once again.

## Taking a video

Click on the menu button in the bottom right corner and select the “Video” mode under the “Camera Settings”. Then click the “X” in the top left corner of the menu to exit and return to the home screen. In video mode, the shutter button will be displayed as a red record button with a white circle around it. To start recording, click on the record button, the video record time will start and be displayed on the left side of the screen underneath the battery icon. To stop recording click on the record button again, the record time will stop.

## Settings Menu – Photos, Video

Photo or Video select

Camera select

Diagnostic Filter select

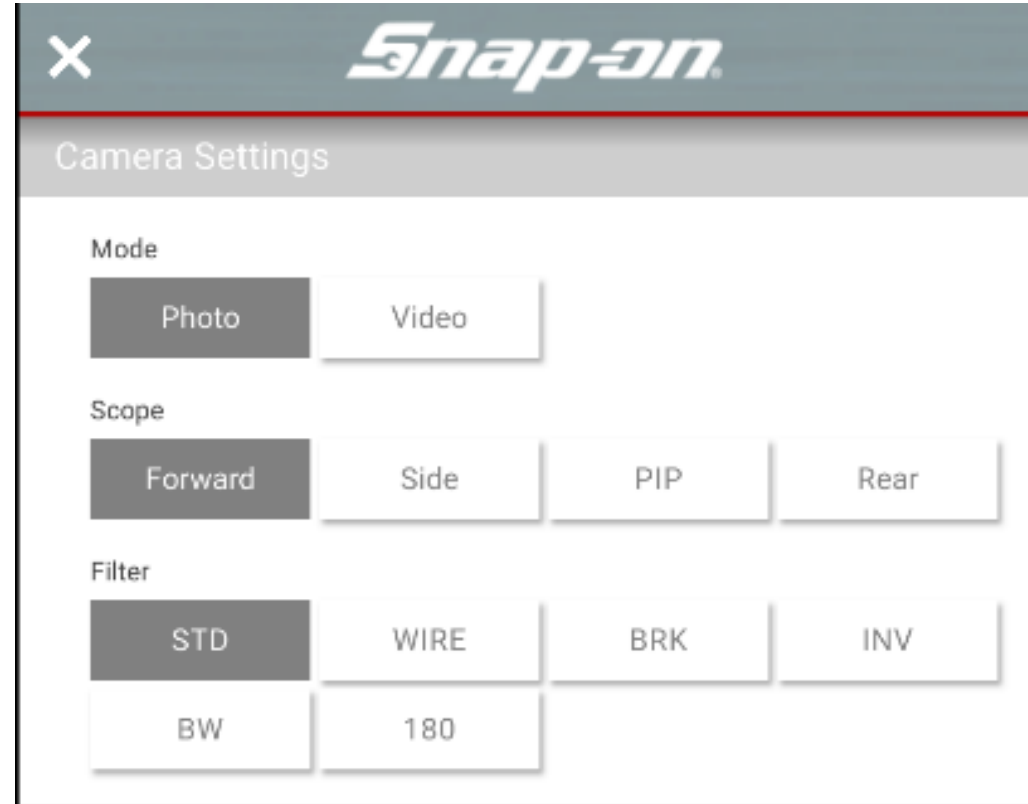

# Settings Menu

Auto shutdown setting

Screen Brightness Control

On screen Time and Date

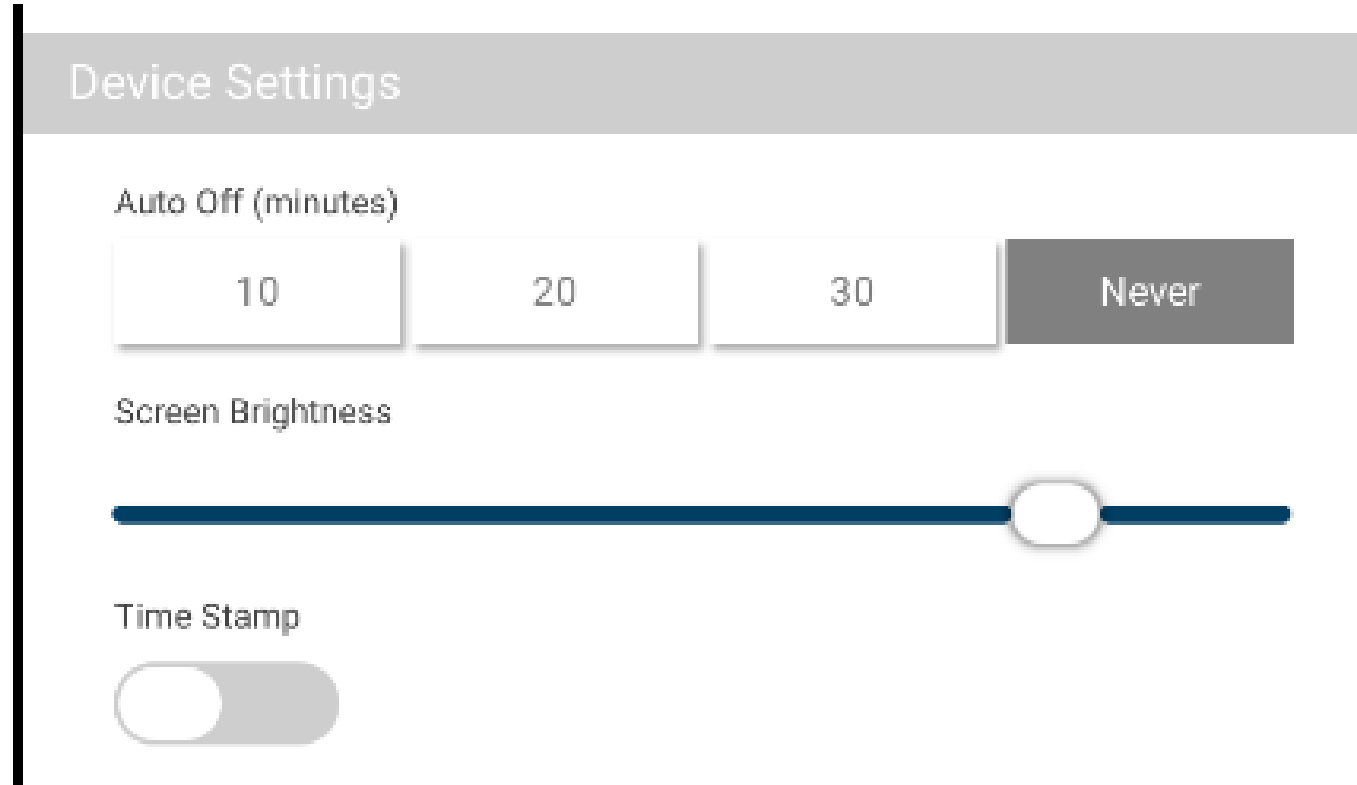

# Settings Menu

Speaker Volume Control

Microphone

Memory Capacity

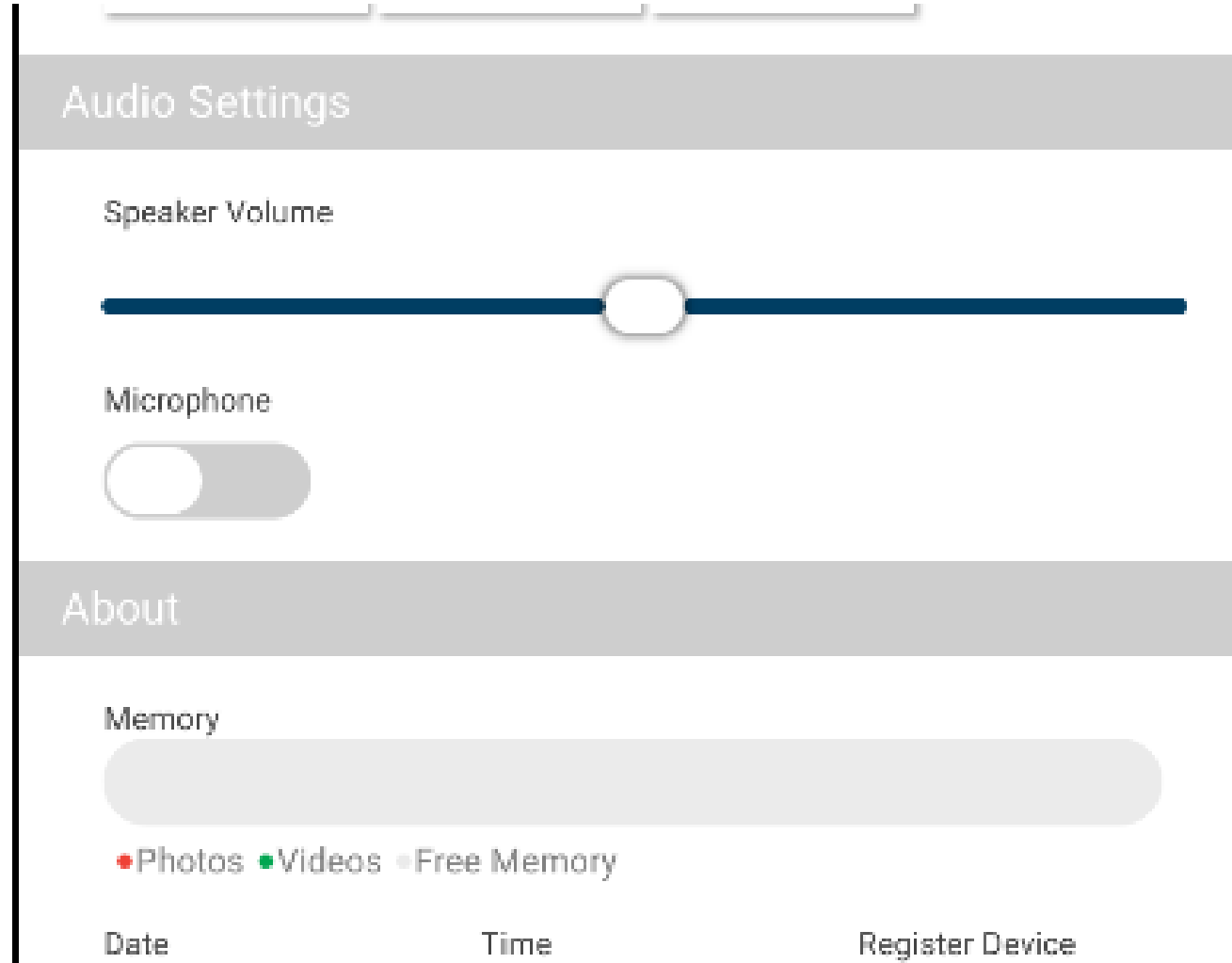



# Settings Menu

Wi-Fi Status

Bluetooth Status

Language Selection



# Settings Menu

Time & Date  
Firmware update  
Licensing Agreement

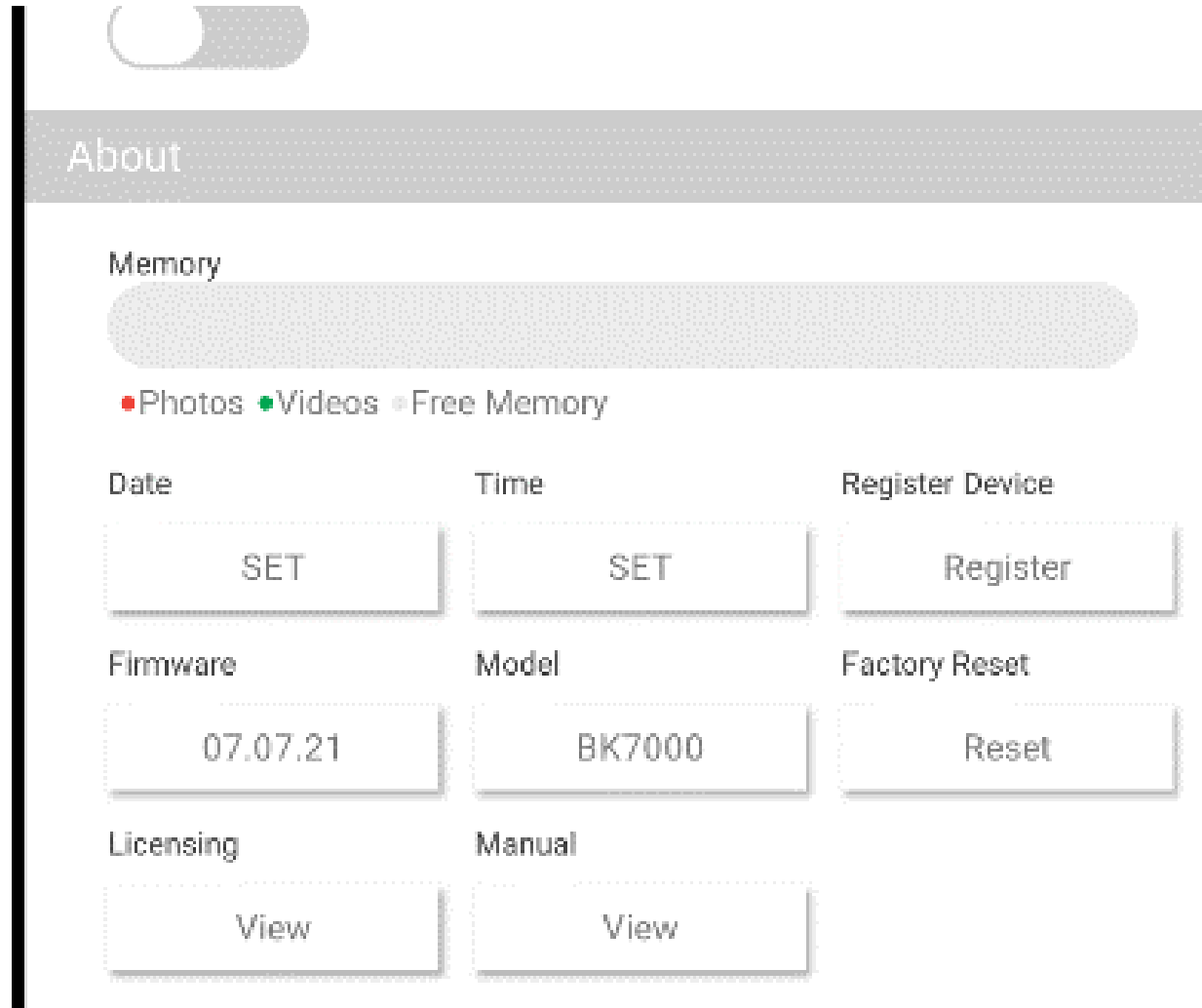

## Viewing pictures and videos

To view pictures and videos, click on the gallery icon.

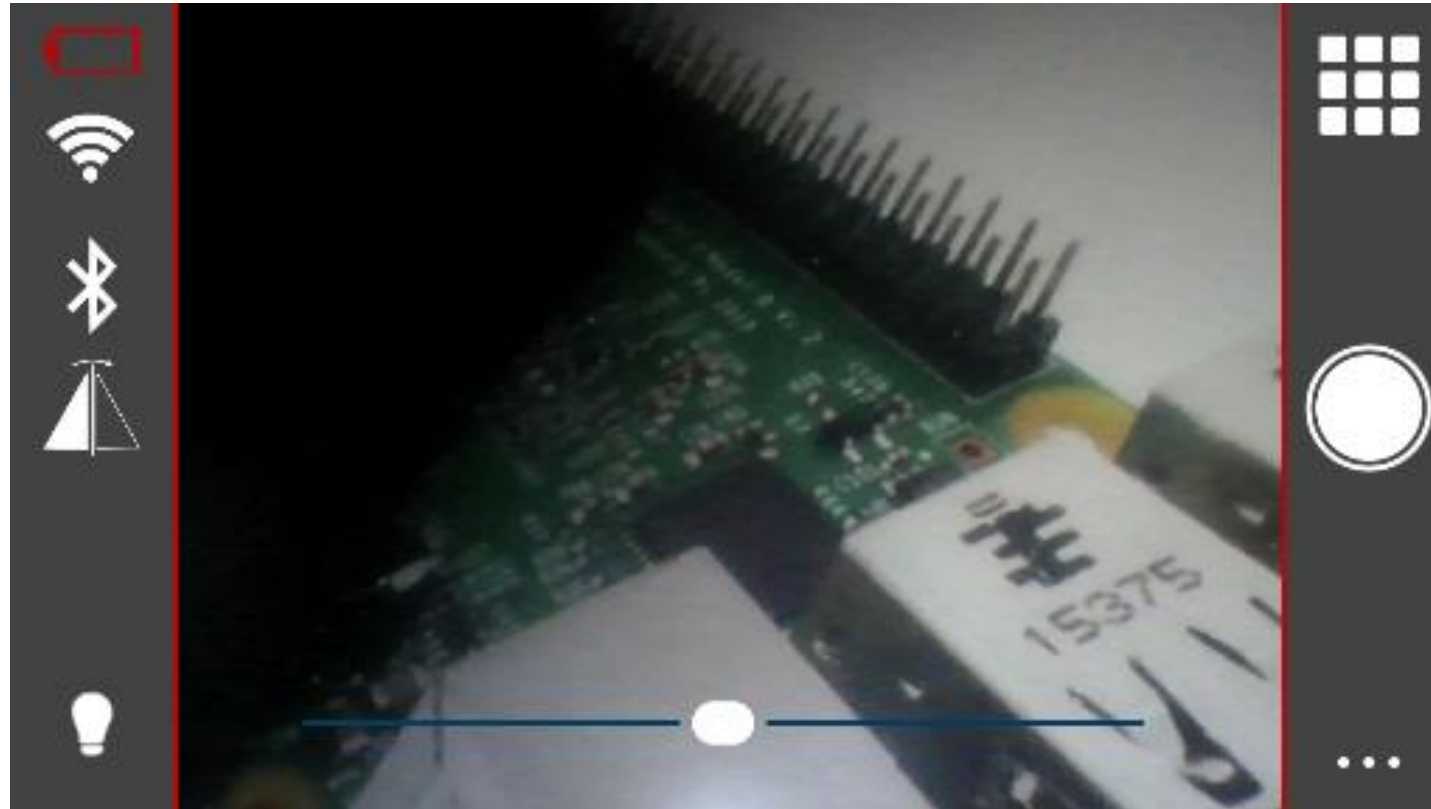

Media Gallery

On the next screen you can view and playback pictures and videos by clicking on them. To delete items out of the gallery, click on the “Select” button in the ... corner, then tap on each picture or image, a check mark will appear in the selection box of each item, click “Delete”.

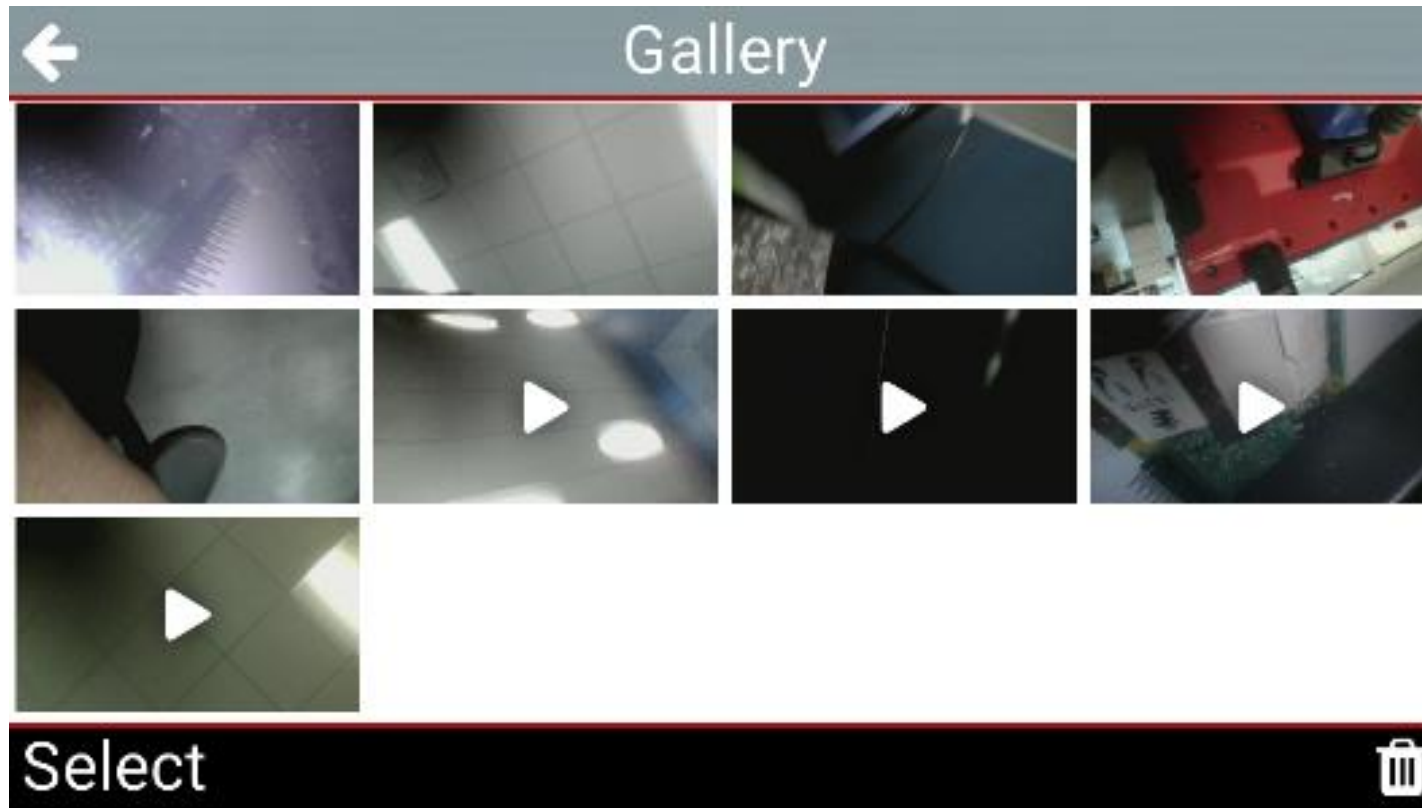

# Audio Annotation



## Annotating a Picture



## Renaming a File



## Transferring photos and videos to computer

*Connect the unit to a computer using the USB-C to USB-A power cord that is included with the unit. Once the external drive appears on the computer, open it. The pictures and videos can be transferred and saved to the location of your choice.*

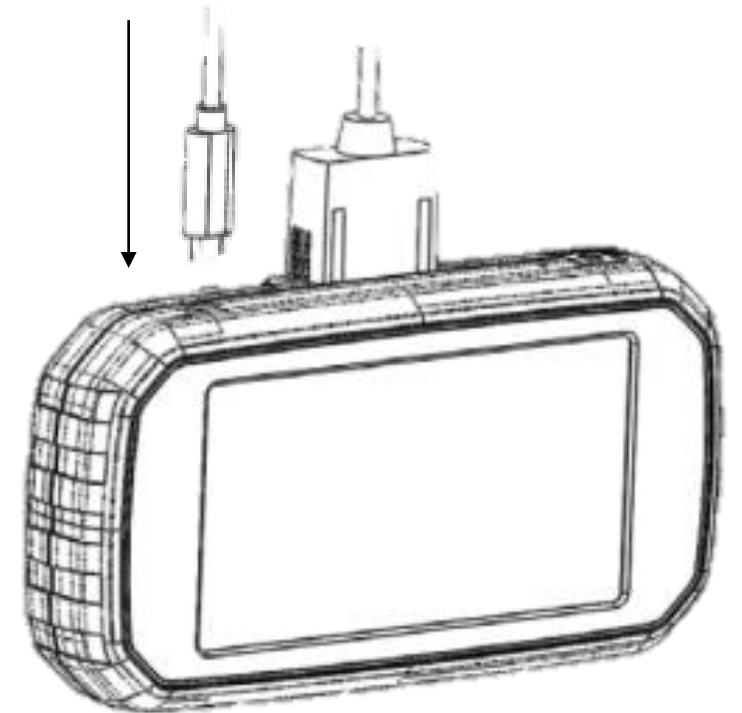



## Connecting to Wi-Fi

*The WiFi can be enabled and disabled in the main menu. Click on the main menu button, scroll down to “Connectivity”, click on “Wifi”.*



Wifi

Not Connected



## **Bluetooth**

The BK7000 has Bluetooth feature to allow the user to listen to audio portion of a video or annotation on compatible devices like wireless ear phones.

### **Supported Bluetooth Devices**

*All devices that require a passcode for connection are categorically unsupported.*

Two of the most common Bluetooth profiles are HFP (hands free) and HSP (headset). Some devices use both profiles, but others have only one of either HFP or HSP.

Please check your device's Bluetooth specifications to find its profile.

If your device supports both HFP and HSP, it is compatible with the BK7000.

Currently, HFP-only and all other profiles are unsupported. Additional compatibility updates are planned for the future.

## Connecting to Bluetooth

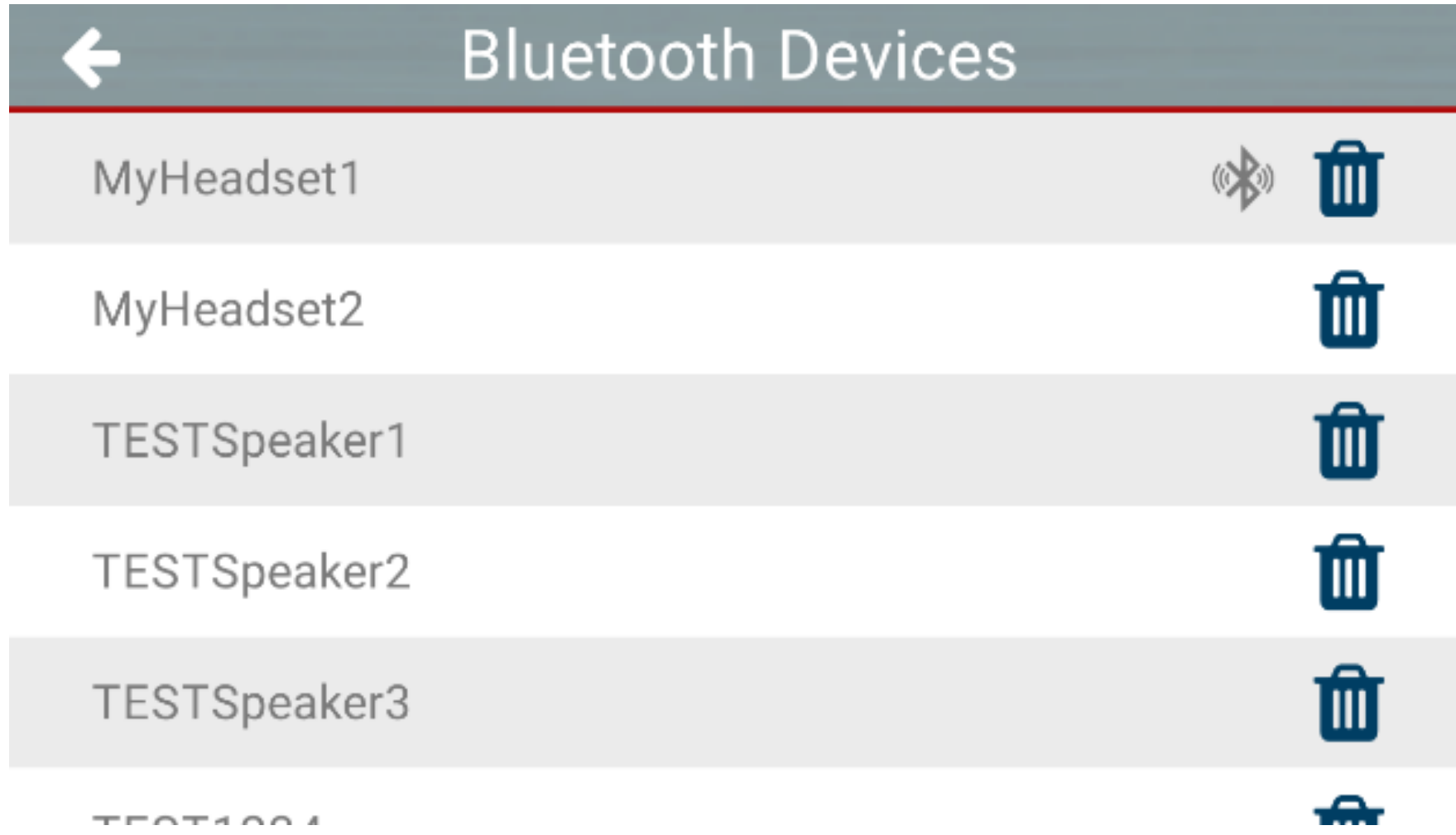

## Connecting to Bluetooth 2

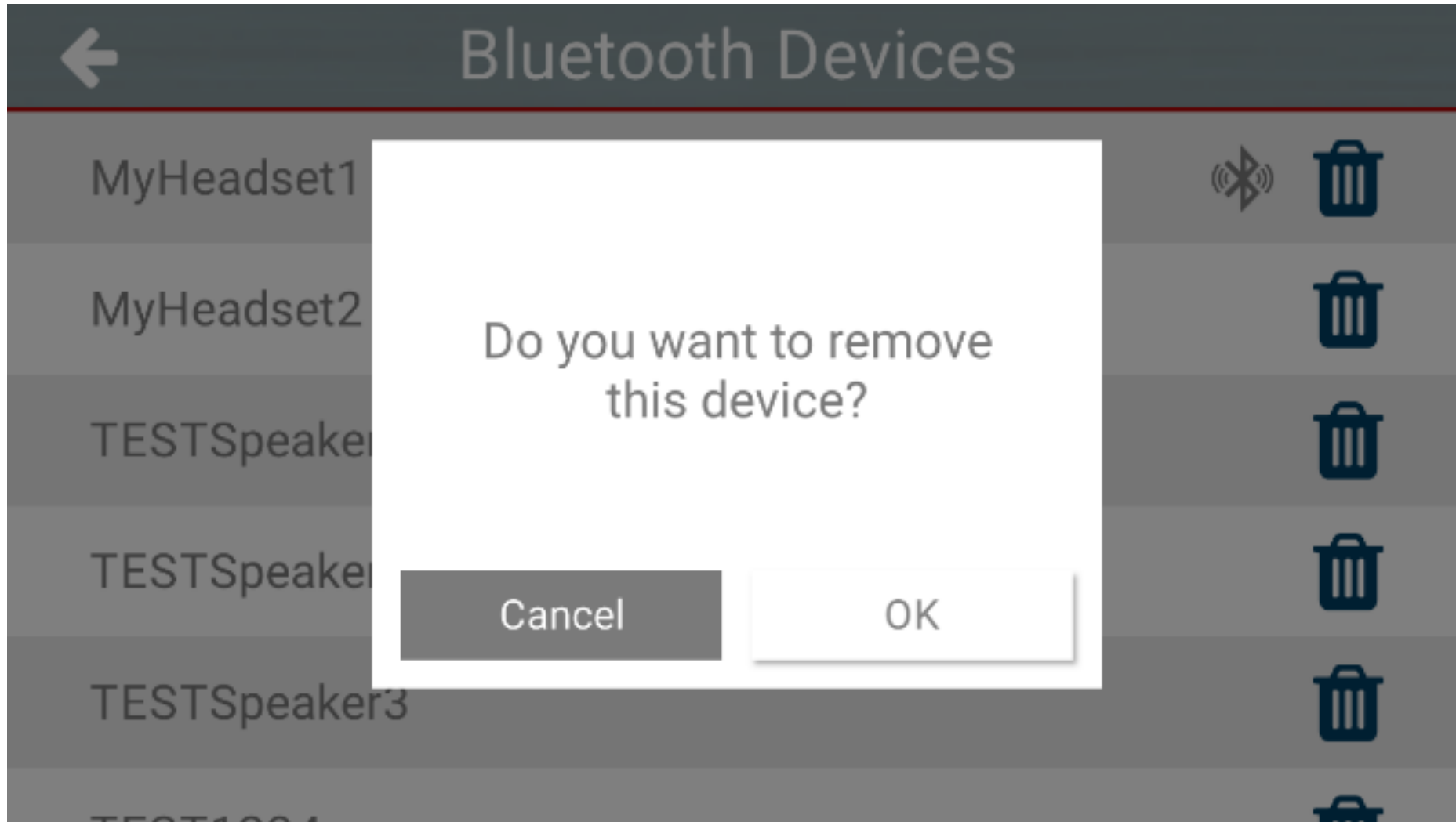

## Connecting to Bluetooth 3

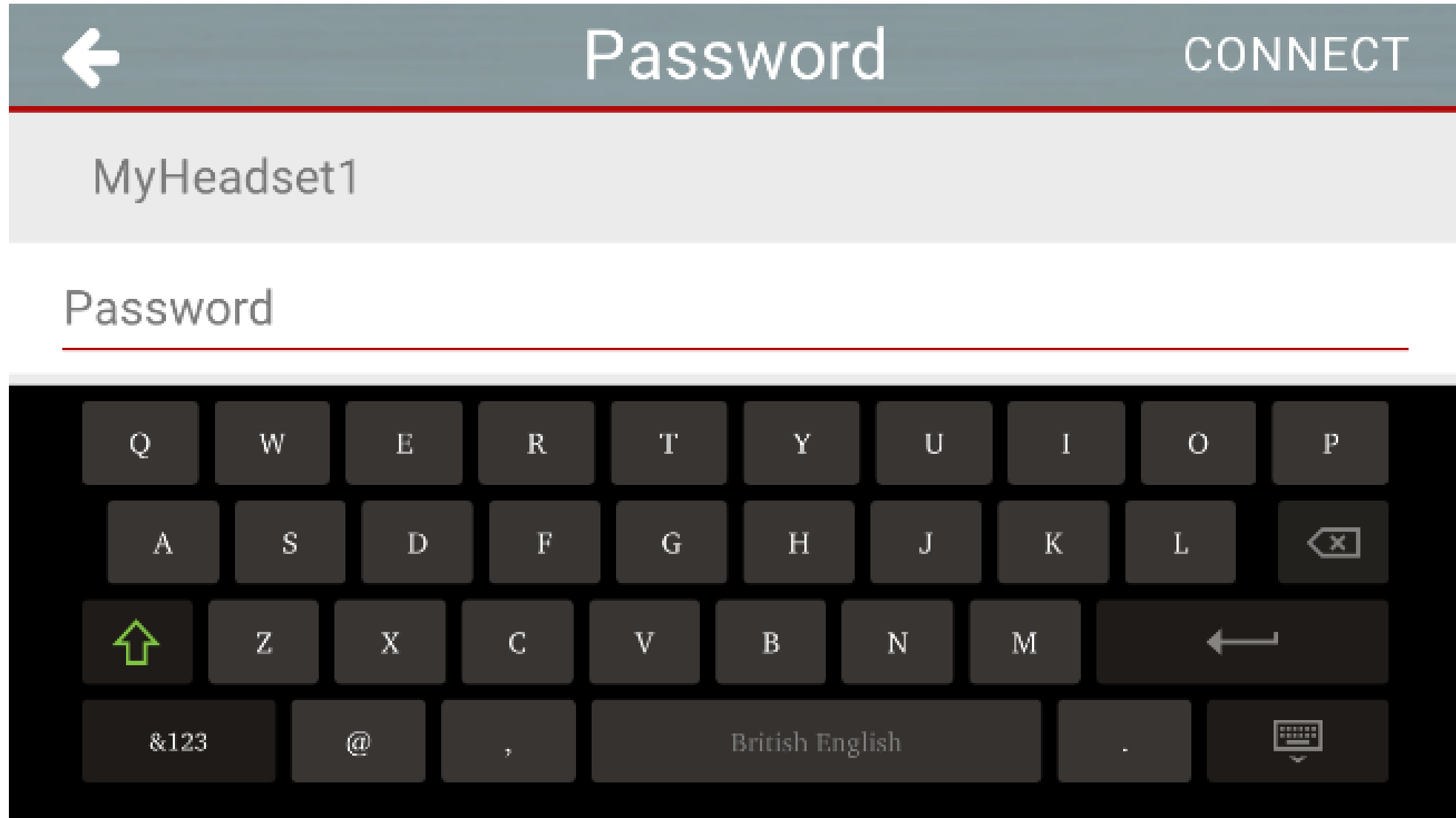

## Resetting BK7000 to factory settings

*Tap the “Reset” button under the “Factory Reset” header. A pop up will appear, confirming that you would like to continue, tap “OK”. The unit will restart. Once the unit fully reboots, you will be prompted to setup and register the unit.*

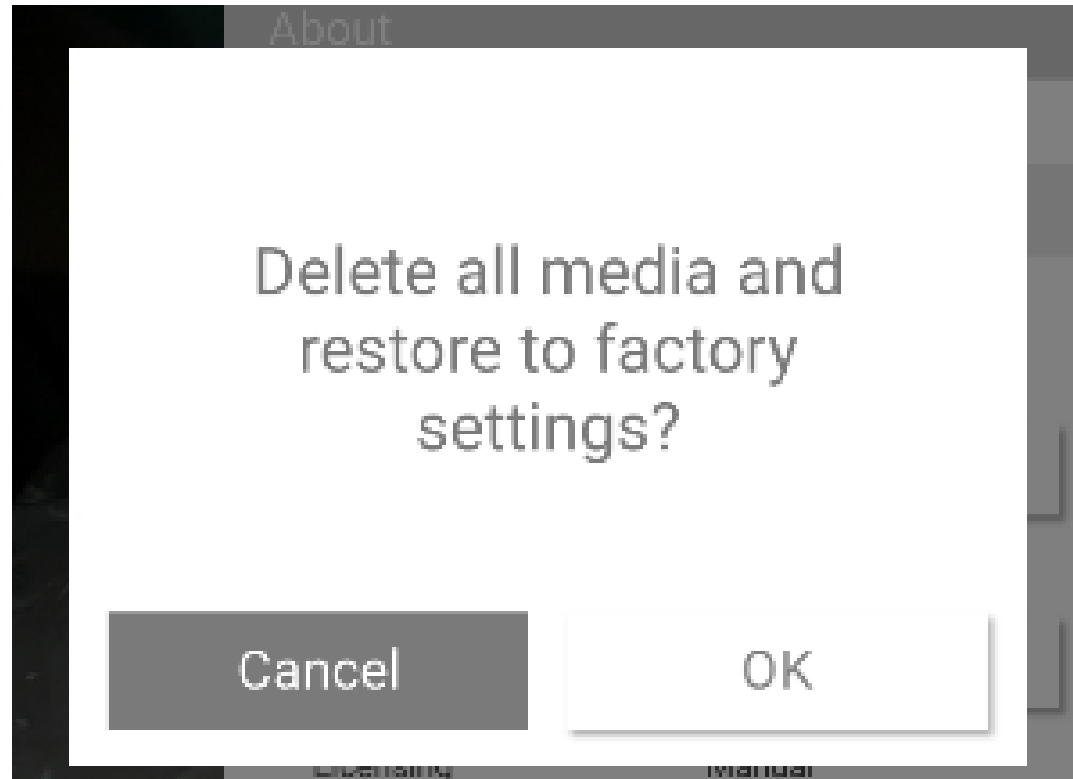

# Troubleshooting

<b>SYMPTOM</b>	<b>POSSIBLE REASON</b>	<b>SOLUTION</b>
Display unit does not display image from imager	The imager is not fully inserted into the unit	Connect imager securely to unit
	Damaged imager	Replace imager
	Imager camera covered	Clean imager lens
Units will not switch on	Battery is critically low	Charge unit until battery indicator light is solid green

Battery does not hold charge	Faulty battery	Contact a nearby service center and start the return process.
Units will not charge	Power supply is not plugged in	Check power supply connection and secure to power source.
	Damaged power supply/power cord	Replace power supply.
	Operating temperature is below or above 32°F and 113°F	Place the unit in an environment of temperature 32°F - 113°F and allow it to return to a neutral temperature before charging the unit.



Image on display is frozen	Processor locked up	Cycle power
Charging LEDs flashing red	Faulty battery/unit	Contact a nearby service center and start the return process.

# Warranty

**Limited Two (2) Year Warranty** Snap-on Tools Company (the “Seller”) warrants only to the original purchaser that under normal use, care and service, the Equipment (except as otherwise provided herein) shall be free from defects in material and workmanship for two years from the date of original invoice. SELLER’S OBLIGATIONS UNDER THIS WARRANTY ARE LIMITED SOLELY TO THE REPAIR OR, AT SELLER’S OPTION, REPLACEMENT OF EQUIPMENT OR PARTS WHICH TO SELLER’S SATISFACTION ARE DETERMINED TO BE DEFECTIVE AND WHICH ARE NECESSARY IN SELLER’S JUDGMENT, TO RETURN THIS EQUIPMENT TO GOOD OPERATING CONDITION. NO OTHER WARRANTIES, EXPRESS OR IMPLIED OR STATUTORY, INCLUDING WITHOUT LIMITATION ANY IMPLIED WARRANTY OR MERCHANTABILITY OR FITNESS FOR A PARTICULAR PURPOSE, SHALL APPLY AND ALL SUCH WARRANTIES ARE HEREBY EXPRESSLY DISCLAIMED. This warranty does not cover (and separate charges for parts, labor and related expenses shall apply to) any damage to, malfunctioning, in operability or improper operation of the Equipment caused by, resulting from or attributable to (A) abuse, misuse or tampering;(B) alteration, modification or adjustment of the Equipment by other than Seller’s authorized representatives; (C) installation, repair or

maintenance (other than specified operator maintenance) of the Equipment or related equipment, attachments, peripherals or optional features by other than Seller's authorized representatives; (D) improper or negligent use, application, operation, care, cleaning, storage or handling; (E) fire, water, wind, lightening or other natural causes; (F) adverse environmental conditions, including, without limitation, excessive heat, moisture, corrosive elements, or dust or other air contaminants, radio frequency interference, electric power failure, power line voltages beyond those specified for the Equipment, unusual physical, electrical or electromagnetic stress and/or other condition outside of Seller's environmental specifications;(G) use of Equipment in combination or connection with other equipment, attachments, supplies or consumable not manufactured or supplied by Seller; or (H) failure to comply with any applicable federal, state or local regulation, requirement or specification governing emission analyzers and related supplies or consumables. Repairs or replacements qualifying under this Warranty will be performed on regular business days during Seller's normal working hours within a reasonable time following purchaser's request. All requests for Warranty service must be made during the stated warranty period. This Warranty is nontransferable.

# Snap-on Service Center Locations

## **Eastern Repair Center (USA)**

6320 Flank Drive

Harrisburg, PA 17112 USA

Toll Free # - (USA only): (800)-848-5067

Telephone: (717) 652-7914

Fax: (717) 652-7123

## **Snap-on Tools (Australia) Pty Ltd**

National Distribution Centre

Unit 6/110 Station Road

PO Box 663

Seven Hills, NSW 1730 Australia

Telephone: (61) 2-9837-9100

Fax: (61) 2-9624-2578

email: [sota.webmasters@snapon.com](mailto:sota.webmasters@snapon.com)

**Northern Repair Center (USA)**

3011 E. RT 176, Dock 8

Crystal Lake, IL 60014

Toll Free # - (USA only): (877) 777-4412

Telephone: (815) 479-6850

Fax: (815) 479-6857

**Snap-on Tools Singapore PTE, Ltd.**

25 Tagore Lane #01-01

Singapore 787602

Telephone: +(65) 6451-5570

Fax: +(65) 6451-5574

email: [esale.sg@snapon.com](mailto:esale.sg@snapon.com)

Internet: <http://snapon.com.sg>

**Western Repair Center (USA)**

3602 Challenger Way

Carson City, NV 89706 USA

Toll Free # - (USA only): (888) 762-7972

Telephone: (775) 883-8585

Fax: (775) 883-8590

**Snap-on Tools Japan, K.K.**

Snap-on, Bahco, and Cartec

Also serving Taiwan and Micronesia

(Distribution Center and Technical Repair Center)

2-1-6 Shinkiba, Koto-ku,

Tokyo, 136-0082 JAPAN

Telephone: +81 3 5534 1280

Fax: +81 3 5534 1284

email: SOJ-INFO@snapon.co.jp

OEM, National Accounts, GSA

Distribution: +81 3 5534 1300

Industrial: +81 3 5534 1281

BAHCD: +81 3 5534 1301

Technical Repair Center: +81 3 5534 1289

**Snap-on UK Repair Centre**

Snap-on Tools, Ltd.

Telford Way, Kettering

Northants, NN16 8UN ENGLAND

Telephone: 01536 413855

Fax: 01536 410740

**Snap-on Tools of Canada Repair Center**

7403 48th St. S.E.

Calgary, Alberta T2C 4H6 CANADA

Toll Free #: (866) 824-0525

Telephone: (403) 720-4525

Fax: (403) 720-4524

email: [canadianquestions@snapon.com](mailto:canadianquestions@snapon.com)